

**Huawei FusionServer X6000**

# Technical White Paper

**Issue** 01  
**Date** 2018-05-21



**Copyright © Huawei Technologies Co., Ltd. 2018. All rights reserved.**

No part of this document may be reproduced or transmitted in any form or by any means without prior written consent of Huawei Technologies Co., Ltd.

## **Trademarks and Permissions**



HUAWEI and other Huawei trademarks are trademarks of Huawei Technologies Co., Ltd.

All other trademarks and trade names mentioned in this document are the property of their respective holders.

## **Notice**

The purchased products, services and features are stipulated by the contract made between Huawei and the customer. All or part of the products, services and features described in this document may not be within the purchase scope or the usage scope. Unless otherwise specified in the contract, all statements, information, and recommendations in this document are provided "AS IS" without warranties, guarantees or representations of any kind, either express or implied.

The information in this document is subject to change without notice. Every effort has been made in the preparation of this document to ensure accuracy of the contents, but all statements, information, and recommendations in this document do not constitute a warranty of any kind, express or implied.

## **Huawei Technologies Co., Ltd.**

Address: Huawei Industrial Base  
Bantian, Longgang  
Shenzhen 518129  
People's Republic of China

Website: <http://e.huawei.com>

# About This Document

## Purpose

This document describes the X6000 server in terms of appearance, features, system architecture, components, security management, system management, and technical specifications.

## Intended Audience



This document is intended for:



- Huawei technical support engineers
- Technical support engineers from channel partners
- Enterprise administrators

## Symbol Conventions

The symbols that may be found in this document are defined as follows.

Symbol Conventions

Symbol	Description
 <b>DANGER</b>	Indicates an imminently hazardous situation which, if not avoided, will result in death or serious injury.
 <b>WARNING</b>	Indicates a potentially hazardous situation which, if not avoided, could result in death or serious injury.
 <b>CAUTION</b>	Indicates a potentially hazardous situation which, if not avoided, may result in minor or moderate injury.

Symbol	Description
 <b>NOTICE</b>	Indicates a potentially hazardous situation which, if not avoided, could result in equipment damage, data loss, performance deterioration, or unanticipated results. NOTICE is used to address practices not related to personal injury.
 <b>NOTE</b>	Calls attention to important information, best practices and tips. NOTE is used to address information not related to personal injury, equipment damage, and environment deterioration.

## Change History

Changes between document issues are cumulative. The latest document issue contains all the changes made in earlier issues.

### Issue 01 (2018-05-21)

The issue is the first official release.

---

# Contents

---

<b>About This Document.....</b>	<b>ii</b>
<b>1 Product Overview.....</b>	<b>1</b>
1.1 Overview.....	1
1.2 Features.....	2
<b>2 System Architecture.....</b>	<b>4</b>
2.1 Integrated Equipment Design.....	4
2.2 Heat Dissipation Design.....	5
2.3 Management and Monitoring.....	6
2.4 Advantages.....	6
<b>3 Hardware Description.....</b>	<b>8</b>
3.1 Appearance.....	8
3.2 Structure.....	16
3.3 Server Node.....	18
3.4 Fan Module.....	19
3.5 PSU.....	19
3.6 System Backplane and Hard Disk Backplane.....	21
3.7 HMM.....	22
<b>4 Security Management.....</b>	<b>24</b>
4.1 Server Nodes.....	24
4.2 HMM.....	24
<b>5 System Management Features.....</b>	<b>26</b>
5.1 iBMC Features.....	26
5.2 HMM Features.....	28
5.3 Management Principles.....	28
5.4 Management Mode.....	29
<b>6 Technical Specifications.....</b>	<b>31</b>
6.1 Chassis Specifications.....	31
6.2 Node Specifications.....	32
6.3 Power Specifications.....	32
6.4 Environmental Specifications.....	33
<b>7 Maintenance.....</b>	<b>41</b>

---

<b>8 Certifications.....</b>	<b>44</b>
8.1 Certifications.....	44
8.2 Standards and Protocols.....	45
<b>A Acronyms and Abbreviations.....</b>	<b>48</b>

# 1 Product Overview

---

## 1.1 Overview

### 1.2 Features

## 1.1 Overview

The Huawei X6000 server is a next-generation 2U high-density server designed for ISP customers inside and outside China, Internet, high-performance computing (HPC), cloud computing, and data center applications. Built on an architecture optimized for software-defined storage (SDS), Big Data, and software-defined infrastructure (SDI), it is ideal for large-scale server deployment.

The X6000 is a multi-node server that is 2U high. It features high density, reliability, scalability, and energy efficiency, and is easy to manage and maintain.

Market positioning of the X6000 is as follows:

- Provides customized server solutions that offer low power consumption, easy maintenance, and rapid deployment for Internet and data center applications.
- Provides a hardware platform to meet requirements for high reliability and virtualization performance for HPC, cloud computing, and ISP applications.

The X6000 supports three flexible configurations:

A: 24 x 2.5-inch SAS or SATA hard disks at the front

B: 24 x 2.5-inch SAS or SATA hard disks, or NVMe SSDs at the front

C: 12 x 3.5-inch SAS or SATA hard disks at the front

**Figure 1-1** shows an X6000 with 2.5-inch hard disks.

**Figure 1-1** X6000 server

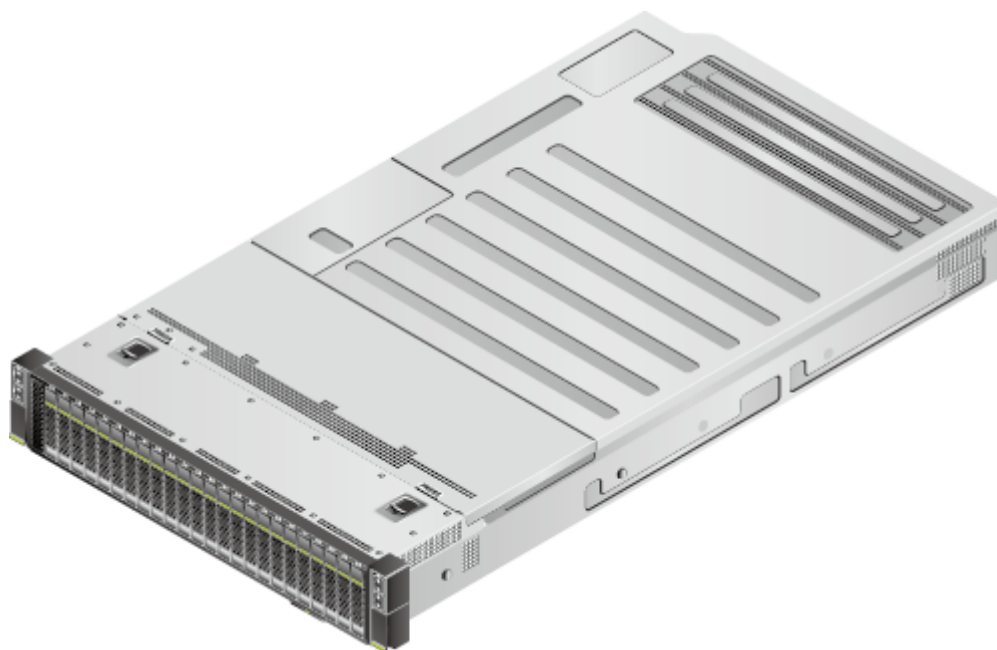

## 1.2 Features

### Ultra-High Density Design Reducing Equipment Footprint

The X6000 provides higher density than conventional rack servers, reducing the footprint in equipment rooms.

- The X6000 provides computing density twice that of a conventional 1U rack server and four times that of a conventional 2U rack server, greatly improving space utilization in equipment rooms.
- Each node supports six 2.5-inch or three 3.5-inch hard disks.

### Unified Management and Easy Maintenance

The X6000 leverages the blade server architecture to provide unified management and easy maintenance.

- The X6000 uses the iBMC+HMM management. By incorporating advantages of rack and blade servers, the X6000 allows nodes to be installed at the rear and supports rear cabling.
- The modular design and hot-swappable key components greatly improve O&M efficiency.

### Shared Architecture and High Energy Efficiency

All server nodes in an X6000 chassis share power supplies and the heat dissipation system.

- Server nodes share two PSUs and four fan modules, simplifying deployment and increasing PSU and fan module utilization.
- The X6000 uses the Dynamic Energy Management Technology (DEMT) to control system energy consumption and increase the energy efficiency.

### Redundancy Design and High Reliability



The X6000 adopts a reliable system architecture to ensure stable and long-term operation.

- The X6000 supports redundant fan modules and PSUs as well as RAID configuration, preventing data loss and service interruption.
- The X6000 uses carrier-class components and manufacturing processes to improve stability and ensure a longer life cycle.

#### **Support for Customization**

- Huawei designs the product and owns the intellectual property.
- Huawei provides quick customized development and delivery.

# 2 System Architecture

---

[2.1 Integrated Equipment Design](#)

[2.2 Heat Dissipation Design](#)

[2.3 Management and Monitoring](#)

[2.4 Advantages](#)

## 2.1 Integrated Equipment Design

The X6000 is a next-generation server that has the following features:

- The server is 2U high and supports four server nodes, each with six 2.5-inch or three 3.5-inch hard disks.
- The server nodes share PSUs, and support PSUs in 1+1 redundancy mode when CPUs of 205 W or lower are used.
- All server nodes in a chassis share fan modules in N+1 redundancy mode.
- The server supports rear cable routing and maintenance and network controller sideband interface (NC-SI).
- The HMM provides an aggregation network port on the rear panel using the port aggregation module. This aggregation network port is connected to the iBMC of the four server nodes using one management network cable. This means that only one port for the out-of-band management system interfaces with external devices.

[Figure 2-1](#) shows an X6000 server.

Figure 2-1 X6000 server system architecture

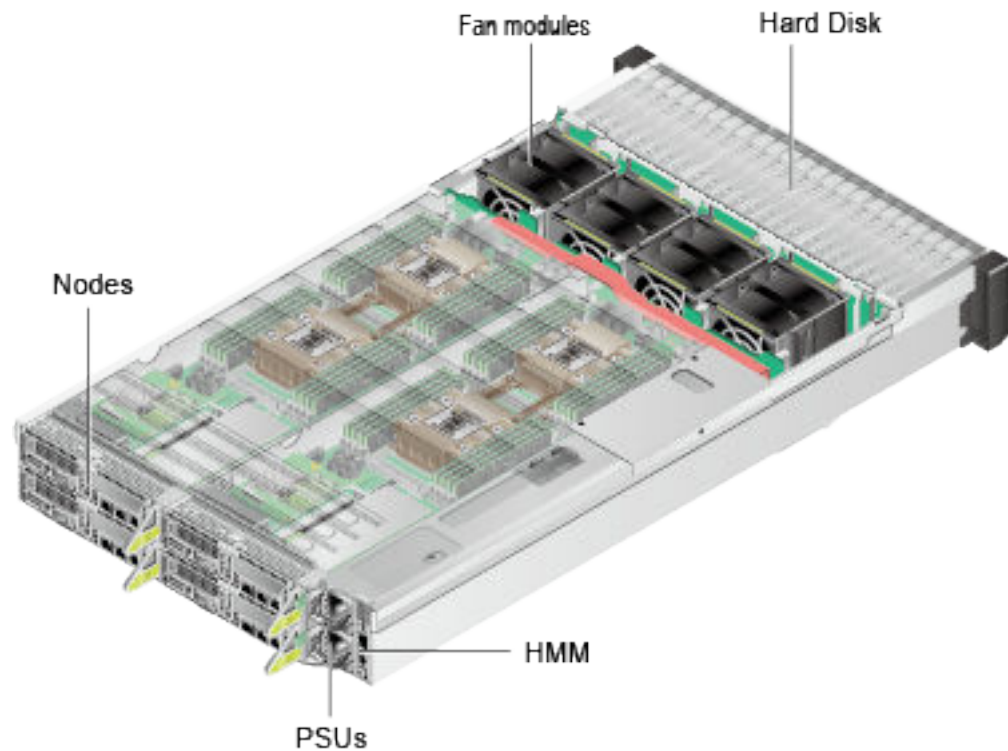

## 2.2 Heat Dissipation Design

X6000 heat dissipation analysis:

- The system draws cool air in from the front panels of hard disks, delivers the cool air through the hard disks, fan modules, system backplane, server nodes, processors, and dual in-line memory modules (DIMMs), and then exhausts the air from the rear.
- The server uses four 8080 counter rotary fans with high air flow pressure to improve the X6000 heat dissipation capability, achieving the maximum configuration, power consumption density, and temperature in the industry.
- The 8080 convection fans use DTS 2.0 control to ensure low power consumption.
- The X6000 minimizes noise through speed adjustment, shock absorption, and noise isolation design.
- The airflow of counter-rotating fans with high air flow pressure and common fan modules increases by 10%. The refined ventilation channel design centralizes the system heat dissipation capability to heat-sensitive components. Temperature sensors are distributed to cover all areas of heat concentration, facilitating accurate fan speed adjustment. The cellular panel allows a 10% more air volume than square holes. The smooth and efficient PID algorithm for speed adjustment ensures long-term stable system operating at 35°C (95°F).

---

### NOTICE

Do not block air vents to prevent device damage due to poor heat dissipation.

---

## 2.3 Management and Monitoring

- The system adopts an iBMC+HMM two-layer management architecture. The iBMC manages each node over the Intelligent Platform Management Interface (IPMI), keyboard, video, and mouse (KVM), or virtual DVD-ROM drive. The HMM implements the chassis management, which includes management for fan modules, PSUs, and chassis assets. The node panel provides GE management ports for customers to manage nodes, chassis, and models.
- The chassis provides a GE aggregation port for customers to visit HMM and iBMC modules and manage the chassis and nodes.
- The HMM and fan control board (FBC) implement fan module monitoring and management. The FBC provides four independent pulse-width modulation (PWM) control signals for adjusting the fan speed and eight TACH signals for detecting the fan speed.  
 The HMM and iBMC determine a proper speed based on speed adjustment algorithms and deliver the speed to the fan board to control the fan speed. The fan backplane detects the operating status of the fan modules through the rotation speed feedback signals, and reports to the HMM for the fan module health management.
- PSU monitoring and management: The HMM provides an inter-integrated circuit (I2C) for managing the PSUs and general purpose input/output (GPIO) pins for detecting the PSU installation status and PWROK state. The HMM supports queries on PSU input power, PSU installation status, and PSU alarms. **Figure 2-2** shows the X6000 management and monitoring design.

**Figure 2-2** X6000 monitoring and management design

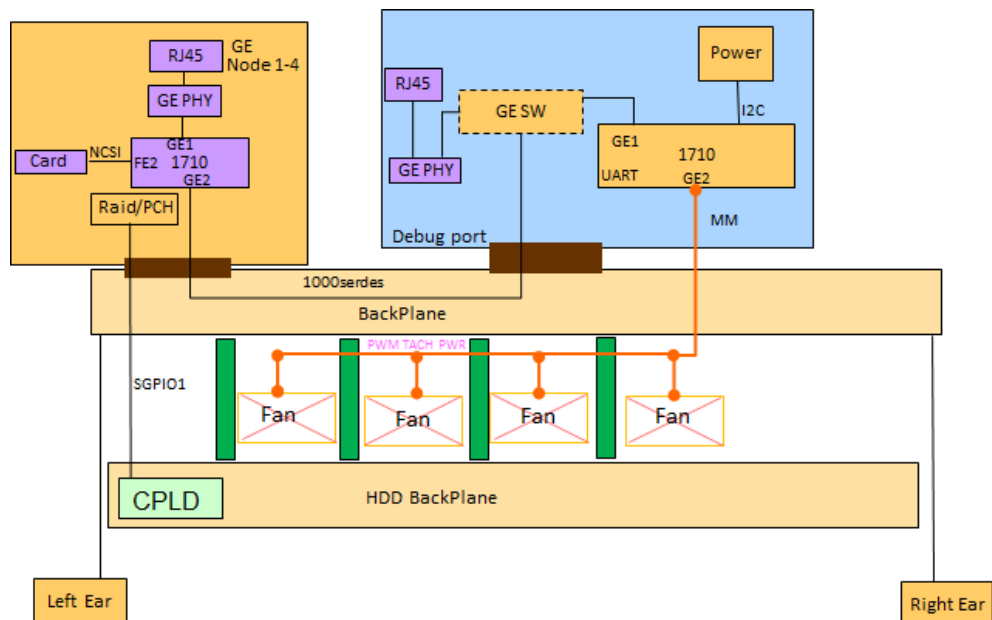

## 2.4 Advantages

- The new high-density server system architecture developed by Huawei supports rear cable routing and maintenance, and maintenance in the cold air area.

- Unified 2U architecture. The NVMe model supports up to 24 NVMe SSDs, and the combined configuration of NVMe SSDs and SAS or SATA HDDs.
- The SAS or SATA model supports 24 2.5-inch or 12 3.5-inch SAS or SATA hard disks.
- The X6000 uses a modular design and supports the hot-swappable server nodes, hard disks, PSUs, and easy I/O module replacement, improving maintenance efficiency.
- The X6000 employs the unique iBMC+HMM management. The Huawei-developed iBMC manages server nodes while the HMM manages the fan modules, PSUs, and chassis assets.
- All nodes share the system power supply and fan modules, improving PSU conversion efficiency and reducing the system heat dissipation energy consumption, which maximizes system energy efficiency.

 **NOTE**

The guide rails and CMA are required for fan module hot swap.

# 3 Hardware Description

## 3.1 Appearance

### 3.2 Structure

### 3.3 Server Node

### 3.4 Fan Module

### 3.5 PSU

### 3.6 System Backplane and Hard Disk Backplane

### 3.7 HMM

## 3.1 Appearance

The X6000 uses a modular design that separates the chassis and server nodes. The X6000 chassis is a standard 2U chassis, which can be installed in a standard 19-inch cabinet and supports server nodes of different I/O specifications. Customers can choose server nodes based on service requirements.

**Figure 3-1** Front view of an X6000 (with 2.5-inch hard disks)



1	Server node 1 indicator area	2	Server node 2 indicator area
3	Server node 3 indicator area	4	Server node 4 indicator area
5	Hard disks managed by server node 4	6	Label (including SN)
7	Hard disks managed by server node 3	8	Hard disks managed by server node 2
9	Hard disks managed by server node 1	-	-

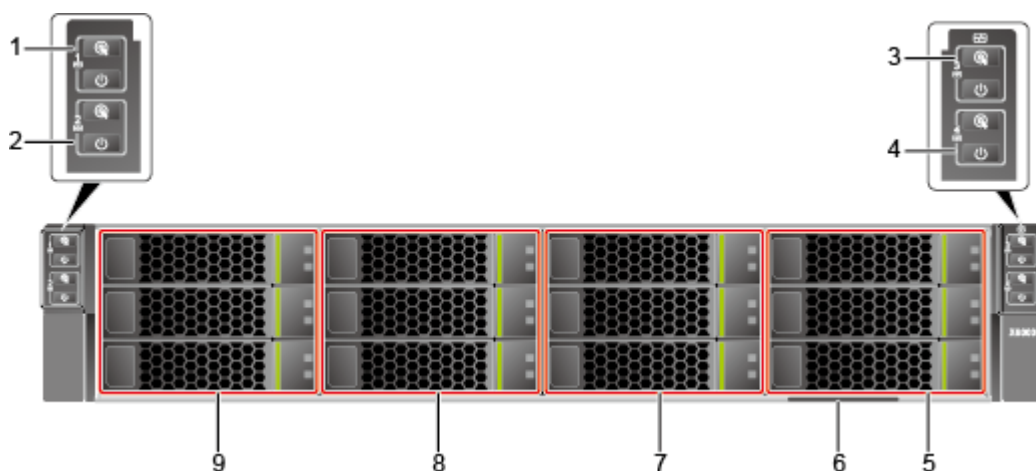

**Figure 3-2** Front view of an X6000 (with 3.5-inch hard disks)



1	Server node 1 indicator area	2	Server node 2 indicator area
3	Server node 3 indicator area	4	Server node 4 indicator area
5	Hard disks managed by server node 4	6	Label (including SN)
7	Hard disks managed by server node 3	8	Hard disks managed by server node 2
9	Hard disks managed by server node 1	-	-

**Table 3-1** describes the indicators on the mounting ear panel.

**Table 3-1** Indicators on the mounting ear panel

Silk Screen	Name	Description
	Server node 1/2/3/4 health indicator	<ul style="list-style-type: none"> <li>● Off: There is no power supply, or the PSU is faulty.</li> <li>● Blinking red at 1 Hz: A major alarm has been generated on the server node.</li> <li>● Blinking red at 5 Hz: A critical alarm has been generated on the server node.</li> <li>● Steady green: The server node is operating properly.</li> </ul>
	Power button/indicator	<p>Power indicator</p> <ul style="list-style-type: none"> <li>● Off: The server is not connected to a power source.</li> <li>● Steady yellow: The server is ready to power on.</li> <li>● Steady green: The server is properly powered on.</li> <li>● Blinking yellow: The iBMC is starting.</li> </ul> <p>Power button</p> <ul style="list-style-type: none"> <li>● When the server is powered on, you can press this button to shut down the OS.</li> <li>● When the server is powered on, you can hold down this button for 6 seconds to power off the server node by force.</li> <li>● When the server is ready to be powered on, you can press this button to start the server.</li> </ul>
	UID button/indicator	<p>The UID button/indicator helps identify and locate a server node in a chassis. You can turn on or off the UID indicator by pressing the UID button or by using the iBMC CLI or WebUI.</p> <p>UID indicator</p> <ul style="list-style-type: none"> <li>● Off: The server node is not being located.</li> <li>● Steady blue: The server node is located.</li> <li>● Blinking blue: The server node has been located and is differentiated from other nodes that have also been located.</li> </ul> <p>UID button</p> <ul style="list-style-type: none"> <li>● You can press this button to turn on or off the UID indicator.</li> <li>● You can press and hold down this button for 4 to 6 seconds to reset the server node iBMC.</li> </ul>



Silk Screen	Name	Description
	Server health indicator	<ul style="list-style-type: none"> <li>● Off: There is no power supply, or the PSU is faulty.</li> <li>● Blinking red at 1 Hz: A major alarm has been generated on the server.</li> <li>● Blinking red at 5 Hz: A critical alarm has been generated on the server.</li> <li>● Steady green: The server is operating properly.</li> </ul>

The X6000 has four server nodes and two power modules at the rear. Each node supports a maximum of two PCIe slots. **Figure 3-3** shows the rear view of an X6000.

**Figure 3-3** Rear view of an X6000

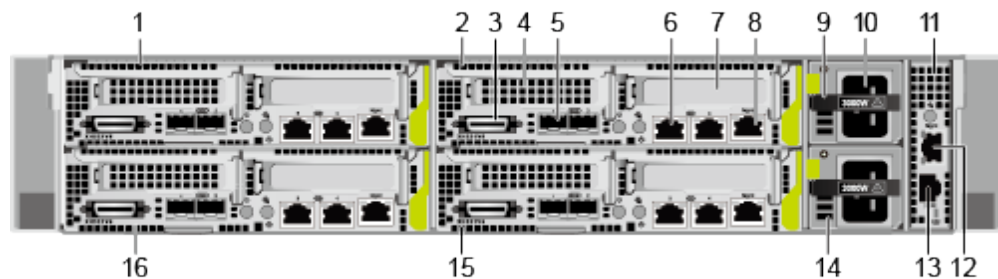

1	Server node 3	2	Server node 1
3	Universal connector port	4	PCIe card/RAID controller card slot
5	10GE LOM optical port	6	GE LOM network port
7	PCIe card slot	8	iBMC management network port
9	PSU 1	10	Power input socket
11	HMM	12	Aggregation network port
13	Serial port	14	PSU 2
15	Server node 2	16	Server node 4

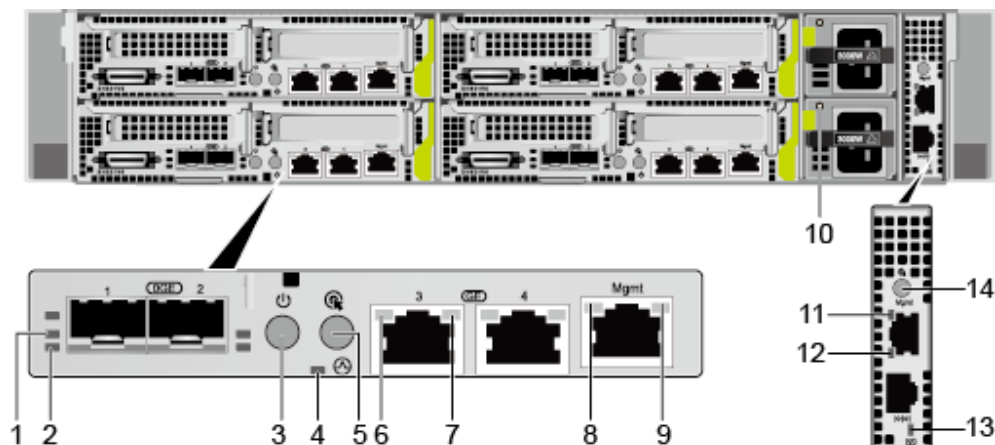

**Figure 3-4** and **Table 3-2** show the indicators and buttons on the X6000 rear panel.

**Figure 3-4** Indicators and buttons on the X6000 rear panel





**Table 3-2** Indicators and buttons on the X6000 rear panel

No.	Silk Screen	Name	Description
1	-	Transmission rate indicator	<ul style="list-style-type: none"> <li>● Off: The network port is not connected, or the data transmission rate is not 10 Gbit/s or 1 Gbit/s.</li> <li>● Steady green: The data transmission rate is 10 Gbit/s.</li> <li>● Steady yellow: The data transmission rate is 1 Gbit/s.</li> </ul>
2	-	Connection status indicator/Data transmission status indicator	<ul style="list-style-type: none"> <li>● Off: The network port is not connected.</li> <li>● Blinking green: Data is being transmitted.</li> <li>● Steady green: The network port is properly connected.</li> </ul>

No.	Silk Screen	Name	Description
3		Power button/indicator	<p>Power indicator</p> <ul style="list-style-type: none"> <li>● Off: The server is not connected to a power source.</li> <li>● Steady yellow: The server is ready to power on.</li> <li>● Steady green: The server is properly powered on.</li> <li>● Blinking yellow: The iBMC is starting.</li> </ul> <p>Power button</p> <ul style="list-style-type: none"> <li>● When the server is powered on, you can press this button to shut down the OS.</li> <li>● When the server is powered on, holding down this button for 6 seconds will power off the server node.</li> <li>● When the server is ready to be powered on, you can press this button to start the server.</li> </ul>
4		Health indicator	<ul style="list-style-type: none"> <li>● Off: There is no power supply, or the PSU is faulty.</li> <li>● Blinking red at 1 Hz: A major alarm has been generated on the server.</li> <li>● Blinking red at 5 Hz: A critical alarm has been generated on the server.</li> <li>● Steady green: The server is operating properly.</li> </ul>

No.	Silk Screen	Name	Description
5		UID button/indicator	<p>The UID button/indicator helps identify and locate a server node in a chassis. You can turn on or off the UID indicator by pressing the UID button or by using the iBMC CLI or WebUI.</p> <p>UID indicator</p> <ul style="list-style-type: none"> <li>● Off: The server node is not being located.</li> <li>● Steady blue: The server node has been located.</li> <li>● Blinking blue: The server node has been located and is differentiated from other nodes that have also been located.</li> </ul> <p>UID button</p> <ul style="list-style-type: none"> <li>● You can press this button to turn on or off the UID indicator.</li> <li>● You can press and hold down this button for 4 to 6 seconds to reset the iBMC.</li> </ul>
6	-	Data transmission status indicator	<ul style="list-style-type: none"> <li>● Off: No data is being transmitted.</li> <li>● Blinking yellow: Data is being transmitted.</li> </ul>
7	-	Connection status indicator	<ul style="list-style-type: none"> <li>● Off: The network port is not connected.</li> <li>● Steady green: The network port is properly connected.</li> </ul>
8	-	Data transmission status indicator	<ul style="list-style-type: none"> <li>● Off: No data is being transmitted.</li> <li>● Blinking yellow: Data is being transmitted.</li> </ul>
9	-	Connection status indicator	<ul style="list-style-type: none"> <li>● Off: The network port is not connected.</li> <li>● Steady green: The network port is properly connected.</li> </ul>

No.	Silk Screen	Name	Description
10	-	Power operating status indicator	<ul style="list-style-type: none"> <li>● Off: No AC power is supplied.</li> <li>● Steady green: The power input and output are normal.</li> <li>● Steady orange: The input is normal, but no power output is supplied due to overheat protection, overcurrent protection, short circuit protection, output overvoltage protection, or some component failures.</li> <li>● Blinking green at 1 Hz:                             <ul style="list-style-type: none"> <li>- The input is normal, the server node is standby, and the PSU is in MV12 mode. (The output voltage is 12 V.)</li> <li>- The input is overvoltage or undervoltage.</li> <li>- The PSU is in deep hibernation mode.</li> </ul> </li> <li>● Blinking green at 4 Hz: under online firmware upgrade.</li> </ul>
11	-	Aggregation network port connection status indicator	<ul style="list-style-type: none"> <li>● Off: The network port is not connected.</li> <li>● Steady green: The network port is properly connected.</li> </ul>
12	-	Data transmission status indicator for the aggregation network port	<ul style="list-style-type: none"> <li>● Off: The network port is idle.</li> <li>● Blinking orange: Data is being transmitted over the network port.</li> </ul>
13		Server health indicator	<ul style="list-style-type: none"> <li>● Off: There is no power supply, or the PSU is faulty.</li> <li>● Blinking red at 1 Hz: A major alarm has been generated on the server.</li> <li>● Blinking red at 5 Hz: A critical alarm has been generated on the server.</li> <li>● Steady green: The server is operating properly.</li> </ul>

No.	Silk Screen	Name	Description
14		UID button/indicator	<p>The UID button/indicator helps identify and locate a server in a chassis. You can turn on or off the UID indicator by pressing the UID button or by remotely running a command on the iBMC CLI.</p> <p>UID indicator</p> <ul style="list-style-type: none"> <li>● Off: The server is not being located.</li> <li>● Steady blue: The server has been located.</li> <li>● Blinking blue: The server has been located and is differentiated from other nodes that have also been located.</li> </ul> <p>UID button</p> <ul style="list-style-type: none"> <li>● You can press this button to turn on or off the UID indicator.</li> <li>● You can press and hold down this button for 4 to 6 seconds to reset the iBMC.</li> </ul>

## 3.2 Structure

Figure 3-5 shows the components of an X6000.

Figure 3-5 X6000 components

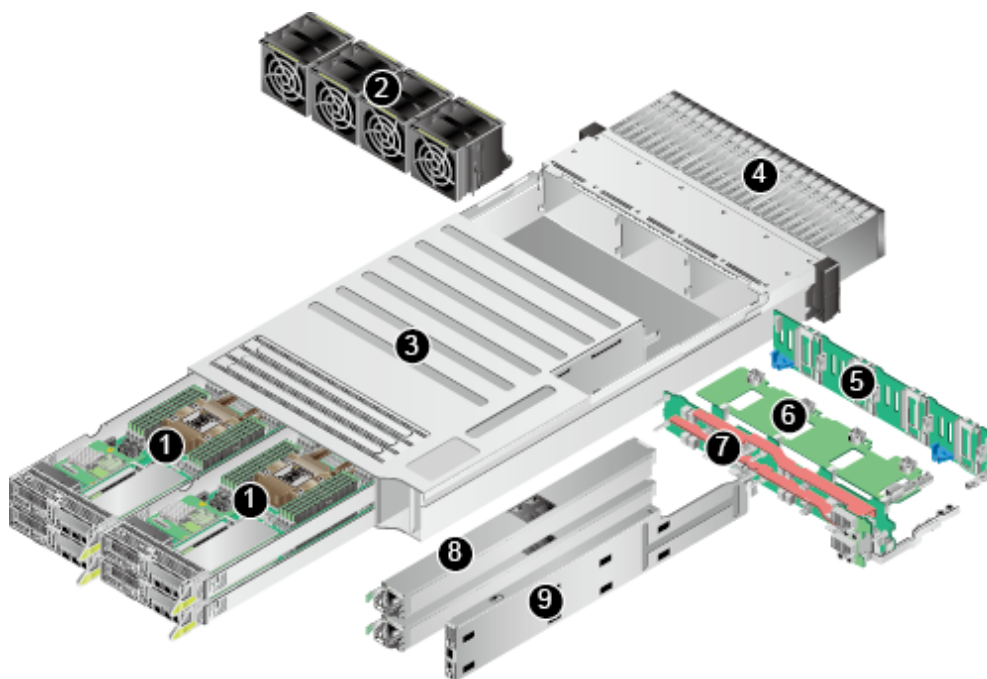

**Table 3-3** describes the X6000 components.

**Table 3-3** X6000 components

No.	Name	Description
1	Server node	XH321 V5.
2	Fan module	Four fan modules in N+1 redundancy mode.
3	Chassis	A 2U chassis housing four server nodes.
4	Hard disk	24 x 2.5-inch hot-swappable SATA/SAS hard disks or NVMe SSDs, or 12 x 3.5-inch hot-swappable SATA/SAS hard disks <b>NOTE</b> If the OS is installed on an NVMe SSD, the BIOS can be set only to UEFI mode.
5	Hard disk backplane	Provides power cable connectors and data transmission channels for hard disks. The X6000 supports three types of hard disk backplanes: <ul style="list-style-type: none"> <li>● Backplane for 2.5-inch SAS/SATA hard disks</li> <li>● Backplane for 2.5-inch NVMe SSDs</li> <li>● Backplane for 3.5-inch SAS/SATA hard disks</li> </ul> <b>NOTE</b> The backplane for NVMe SSDs applies to all 2.5-inch hard disks.
6	Fan backplane	Drives the fans in the chassis.
7	System backplane	A passive backplane used for server nodes to transmit signals to the hyper management module (HMM) and the hard disk backplane. <b>NOTE</b> <ul style="list-style-type: none"> <li>● The SAS/SATA hard disk backplane corresponds to the SAS/SATA system backplane.</li> <li>● The NVMe hard disk backplane corresponds to the NVMe system backplane.</li> </ul>
8	PSU	Supported 2 x 3000 W AC PSUs (compatible with 240 HVDC) <b>NOTE</b> <ul style="list-style-type: none"> <li>● The X6000 PSUs support 1+1 redundancy mode only when the server power consumption is lower than that of a single server.</li> <li>● If the input power is between 100 V and 130 V, the working power of each PSU will decrease to 1200 W.</li> <li>● If the input power is between 200 V and 220 V, or 240 V HVDC, the working power of each PSU will decrease to 2500 W.</li> <li>● If the input power is between 220 V and 240 V, the working power of each PSU is 3000 W.</li> </ul>

No.	Name	Description
9	HMM	<ul style="list-style-type: none"> <li>The HMM implements X6000 chassis management, including temperature monitoring, fan management, power supply management, and server node management.</li> <li>The HMM provides an aggregation network port at the rear of the chassis. The aggregation network port is connected to the iBMC of the four server nodes using one management network cable, so that only one port for the out-of-band management system is displayed to external entities.</li> </ul> <p><b>NOTE</b>                      To log in to the iBMC of a server node, you need to set the management network port as the aggregation network port.</p>

### 3.3 Server Node

The X6000 supports the XH321 V5 server nodes. The node specifications are listed in [Table 3-4](#).

**Table 3-4** Node specifications

Server Node	CPU	IB Card	LOM Configuration
XH321 V5	Intel® Xeon® Scalable 3100, 4100, 5100, 6100, 8100 series processors	Standard IB card	2 GE ports + 2 x 10GE ports

[Figure 3-6](#) shows the XH321 V5 appearances respectively.

**Figure 3-6** Appearance of an XH321 V5

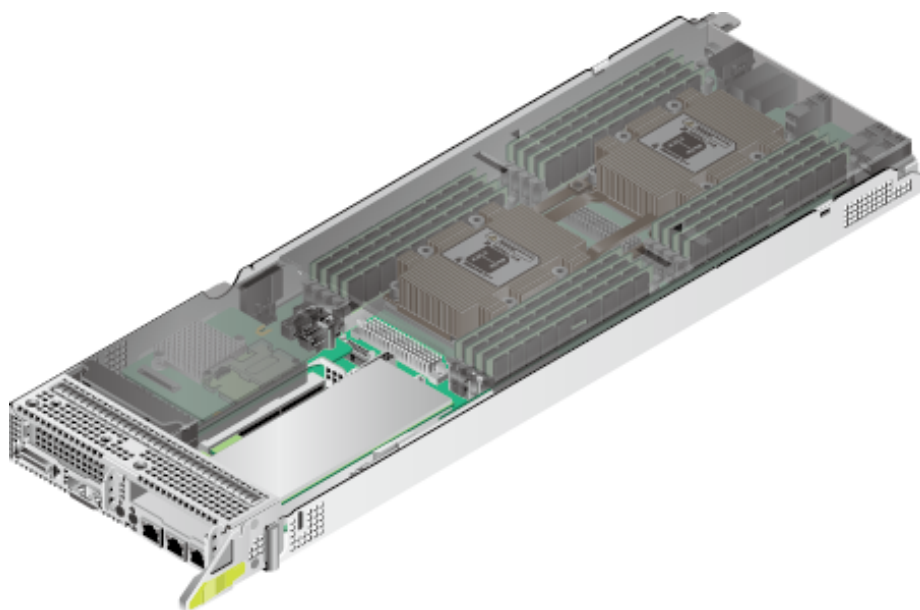



## 3.4 Fan Module

The X6000 uses four 8080 counter rotary fans with high air flow pressure to improve its heat dissipation capability. The HMM controls the fan speed based on server node operating status to implement intelligent heat dissipation, and single-fan failures are allowed.

**Figure 3-7** shows the slots for installing X6000 fan modules.

**Figure 3-7** Slots for installing X6000 fan modules

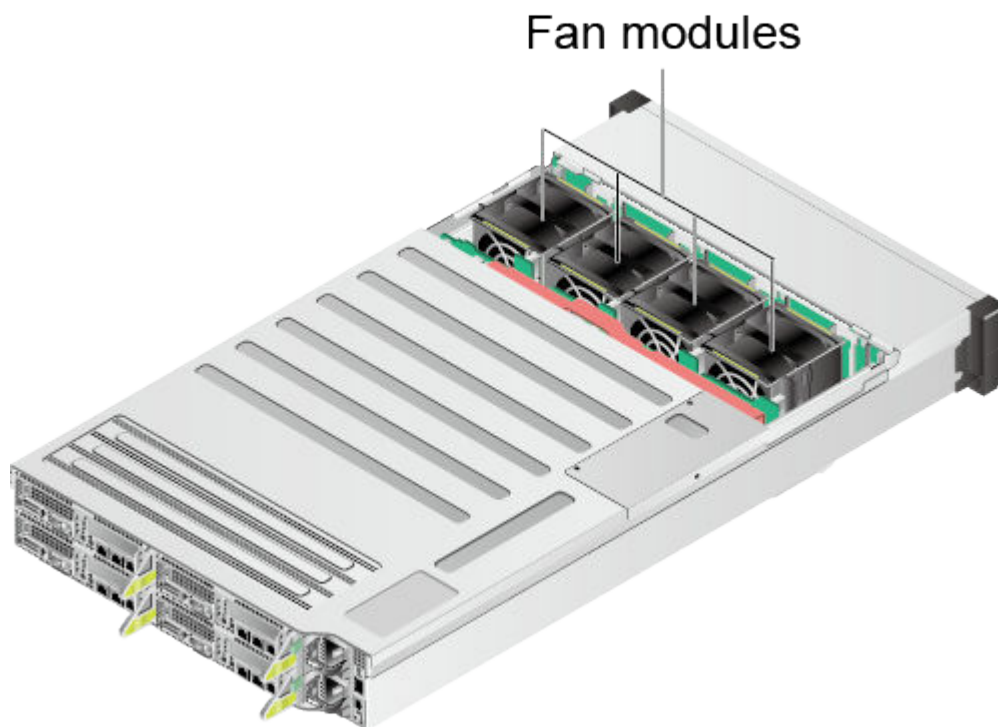

## 3.5 PSU

An X6000 server is equipped with two AC or DC PSUs.

### NOTE

Currently, the X6000 supports only AC and 240 V HVDC PSUs.

Input voltage range of X6000 PSUs:

- AC: 100 V to 130 V AC with an input frequency of 50 or 60 Hz
- AC: 200 V to 220 V AC with an input frequency of 50 or 60 Hz
- AC: 220 V to 240 V AC with an input frequency of 50 or 60 Hz
- 240 V HVDC

The output voltage for the PSUs is 12 V DC.

The following figure shows the appearance of an AC PSU.

**Figure 3-8** Appearance of an AC PSU



The PSU panel consists of a latch, an input socket, and an operating status indicator, as shown in [Figure 3-9](#).

**Figure 3-9** AC PSU panel

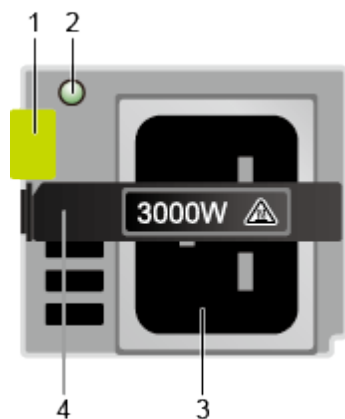

1.	Latch	2	Operating status indicator
3	Power input socket	4	Handle

**NOTE**

C19 16A power cables are required for 3000 W PSUs.

[Table 3-5](#) describes the PSU operating status indicator on the AC PSU panel.

**Table 3-5** PSU operating status indicator description

Name	Status	Description
Operating status indicator	Steady green	The power input and output are normal.
	Steady orange	The power input is normal, but no power output is supplied due to overheat protection, overcurrent protection, short circuit protection, output overvoltage protection, or some component failures.
	Blinking green at 1 Hz	The power input is normal, the server is in standby mode, the PSU enters the MV12 mode (output power: 12 V).
		Input overvoltage or undervoltage occurs.
		The PSU enters the deep hibernation mode.
	Blinking green at 4 Hz	Firmware is being upgraded online.
Off	No AC power is supplied.	

**Table 3-6** lists the PSUs supported by the X6000.

**Table 3-6** PSUs supported by the X6000

BOM	Description	Remarks
02312AEM	Function Module,PAC3000S12-BH,PAC3000S12-BH,Server Power Platinum 3000W	100 V to 130 V AC, 1200 W; 200 V to 220 V AC, 2500 W; 220 V to 240 V AC, 3000 W; 240 V DC, 2500 W.

 **NOTE**

The preceding information is for reference only. For details, see the [Server Compatibility Checker](#).

## 3.6 System Backplane and Hard Disk Backplane

The system backplane is a passive backplane, mainly used for server nodes to transmit signals to the HMM and to the hard disk backplane.

The hard disk backplane supplies power to hard disks and provides data transmission channels, as shown in [Figure 3-10](#).

**Figure 3-10** System backplane and hard disk backplane

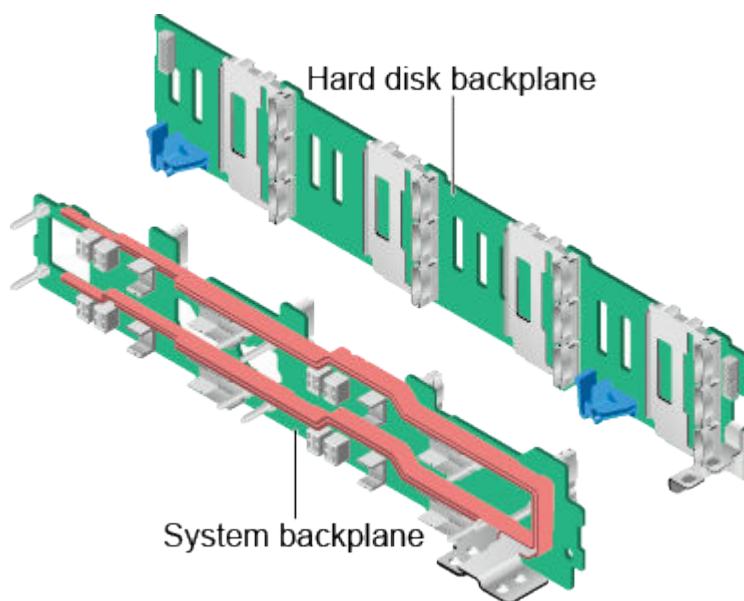

### 3.7 HMM

The HMM implements X6000 chassis management, including ambient temperature monitoring, and fan module, PSU, and node management. Through an aggregation module, the HMM provides an aggregation network port on the chassis rear panel. By connecting only to this aggregation network port, a client can access the iBMC of all server nodes. If this aggregation network port is not used, a standalone management network port is used to connect to the server node iBMC.

**Figure 3-11** shows the front view of the port aggregation module.

**Figure 3-11** Rear view of the HMM

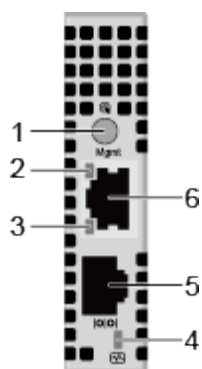

1	UID button/indicator	2	Aggregation network port connection status indicator
3	Data transmission status indicator for the aggregation network port	4	Health indicator

---

5	Serial port	6	Aggregation network port
---	-------------	---	--------------------------

# 4 Security Management

---

## 4.1 Server Nodes

### 4.2 HMM

## 4.1 Server Nodes

Server nodes support security solutions based on the Trusted Platform Module (TPM).

The TPM is a security chip that complies with the Trusted Computing Group (TCG) TPM specification. The TPM, as a hardware-based system security function module, provides data encryption, password protection, authentication, and internal resource protection. The XH321 V5 supports TPM 2.0.

The TPM is connected to the mainboard through a port. You can access a server node with the TPM only after authorization and authentication or in a specific way, which ensures data security based on hardware.

## 4.2 HMM

This topic describes command line-based hierarchical protection, remote Secure Shell (SSH) login, and Simple Network Management Protocol (SNMP) encrypted authentication for the HMM.

### Command Line-based Hierarchical Protection

When a user attempts to log in to the HMM through an Ethernet port, the HMM must authenticate the user to ensure security. Only the user that passes the authentication can log in to the HMM to configure and maintain the HMM.

The HMM uses a hierarchical protection mode for commands, defining three command levels: monitoring level, configuration level, and management level. These command levels are listed in ascending order. Similarly, login users are also classified into three levels: common user, operator, and administrator. After logging to the HMM, users can use only the commands of the levels that are equal to or lower than their own levels. This mechanism effectively controls the authority of login users.

## Remote SSH Login

The HMM supports Secure Shell (SSH). SSH ensures security and provides authentication for user logins and defends user logins against various attacks on an insecure network. The HMM also supports Secure File Transfer Protocol (SFTP) to provide encryption protection for file transfer.

## SNMP Encrypted Authentication

The HMM supports the SNMPv3 and SNMPv3 trap encrypted authentication. When being managed by a network management station through the SNMP protocol, the HMM uses the encrypted authentication mode in user-based security model (USM) to ensure security.

The authentication of SNMPv3 and SNMPv3 trap of the HMM supports MD5 or SHA, and the encryption supports DES or AES. The authentication is based on MD5 by default, which is not secure and easy to be cracked. You are advised to change to the SHA algorithm.

### NOTE

The HMM also supports the SNMPv1, SNMPv2c, FTP, and Telnet protocol, which are disabled by default for security purposes. If you need to use the functions, contact Huawei technical support.

# 5 System Management Features

---

The X6000 provides the HMM+iBMC management architecture. The HMM is in charge of chassis management, including the management of fan modules, PSUs, and the chassis, while the iBMC is responsible for node management based on a user interface (UI).

- Independent node management  
The X6000 uses the next-generation Huawei proprietary iBMC intelligent management system to implement remote server management. The iBMC complies with IPMI 2.0 specifications and provides highly reliable hardware monitoring and management.
- Chassis management  
The X6000 uses the next-generation HMM management system to manage heat dissipation, power supply, and asset information of shared components. The HMM information is displayed to customers on the iBMC. Customers can access the iBMC either through the management network port of a node or through the aggregation network port on the rear panel.

[5.1 iBMC Features](#)

[5.2 HMM Features](#)

[5.3 Management Principles](#)

[5.4 Management Mode](#)

## 5.1 iBMC Features

The iBMC provides the following features:

- Keyboard, video, and mouse (KVM) and text console redirection
- Remote virtual media
- Intelligent Platform Management Interface (IPMI) V2.0
- Simple Network Management Protocol Version 3 (SNMPv3)
- Common information model (CIM)
- Login using web browsers

**Table 5-1** describes the iBMC specifications.



**Table 5-1** iBMC specifications

Specifications	Description
Management interface	Supports the following management interfaces integrated with any standard management system: <ul style="list-style-type: none"> <li>● IPMI V2.0</li> <li>● CLI</li> <li>● HTTPS</li> <li>● SNMPv3</li> <li>● Web</li> <li>● Redfish</li> </ul>
Node fault detection	Detects and locates hardware faults accurate down to components.
Node alarm management	Manages alarms and reports alarms in various ways such as over the SNMP trap, Simple Mail Transfer Protocol (SMTP), and syslog service to ensure uninterrupted 24/7 system operation.
Integrated virtual KVM	Provides remote maintenance measures for troubleshooting and supports a maximum resolution of 1280 x 1024.
Integrated virtual media	Virtualizes local media devices or images into media devices on a remote server, simplifying OS installation. The virtual DVD-ROM drive supports a maximum transmission rate of 8 MB/s.
Web-based user interface	Provides a visual WebUI, simplifying configuration and operation query. The iBMC WebUI supports the following browsers: <ul style="list-style-type: none"> <li>● Internet Explorer 9.0/10.0/11.0</li> <li>● Mozilla Firefox 26.0 or later</li> <li>● Chrome 21.0 or later</li> <li>● Safari 8.0</li> </ul> Compatible JRE environments are as follows: <ul style="list-style-type: none"> <li>● JRE 1.7.0</li> <li>● JRE 1.8.0</li> </ul>
Fault reproduction	Reproduces faults to facilitate fault diagnosis.
Screen snapshot and screen video	Allows users to view screen snapshots and videos without login, which facilitates preventive maintenance inspection (PMI).
Domain name service (DNS) and directory service	Supports domain management and directory services, which significantly simplify network management and configuration.

Specifications	Description
Dual-image backup	Supports software startup from a backup image in case of software crashes.
IPv6	Supports IPv6 to ensure sufficient IP addresses.

## 5.2 HMM Features

The Hyper Management Module (HMM) supports:

- IPMI V2.0
- Command line interface (CLI)

[Table 5-2](#) lists HMM features.

**Table 5-2** HMM features

Feature	Description
Management interface	Supports the following management interfaces integrated with any standard management system: <ul style="list-style-type: none"> <li>● IPMI V2.0</li> <li>● CLI</li> </ul>
Fault detection	Detects and locates hardware faults accurate down to components.
Alarm management	Supports alarm management and reports alarms in various ways, such as syslog service, to ensure uninterrupted and highly reliable system operation.
Asset management	Provides intelligent asset management.
Intelligent power management	Uses the power capping technology to increase deployment density and the dynamic energy saving technology to lower O&M costs.
Aggregation port	Aggregates out-of-band management ports of all nodes and accesses the iBMC of each node to reduce management network cables and maintenance time.

## 5.3 Management Principles

The management principles of the X6000 are as follows:

- The iBMC manages the corresponding server node (IPMI/KVM/virtual DVD-ROM drive). The HMM implements chassis management, including the management of fan modules, PSUs, and other chassis assets.

- The external management interface is displayed on the iBMC of each node. Users can access the iBMC through the iBMC management network port or through the aggregation network port on the HMM.
- The HMM uses the fan backplane to implement fan module monitoring and management. The fan backplane provides four independent pulse-width modulation (PWM) control signals for controlling the fan speed and eight TACH signals for detecting the fan speed.

The HMM and iBMC determine a proper speed based on speed adjustment algorithms and deliver speed data to the fan backplane to control the fan speed. The fan backplane detects the operating status of the fan modules through the rotation speed feedback signals, and reports to the HMM for the fan module health management.

- PSU monitoring and management: The HMM provides an inter-integrated circuit (I2C) for managing the PSUs and general purpose input/output (GPIO) pins for detecting the PSU installation status and PWROK state. The HMM supports queries on PSU input power, PSU installation status, and PSU alarms.

## 5.4 Management Mode

### Access mode

The iBMCs on server nodes and the HMM of X6000 provide independent IP addresses for external use, with which users can access the iBMC and HMM to manage the X6000.

- On each server node, users can:
  - Access the iBMC through the iBMC management network port.
  - Access the iBMC in NC-SI mode through the service network port on the NIC.
  - Access the HMM in transparent transmission mode through the iBMC management network port on each server node.
- Through the aggregation network port, users can:
  - Directly access the HMM through the network port on the HMM.
  - Access the iBMC in aggregation management mode through the network port on the HMM.

### Cable routing

The management network cabling methods are as follows:

- Point-to-point cabling  
The out-of-band management network cables are routed from the server node (default configuration in the BIOS). For details, see [Figure 5-1](#).

**Figure 5-1** Point-to-point cabling

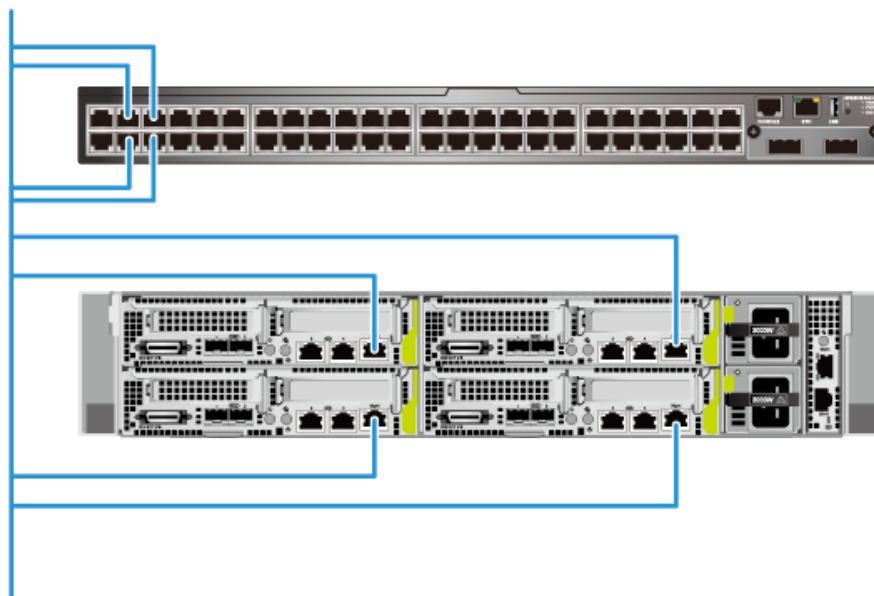

**NOTE**

In NC-SI mode, the management network cable can also be used as a service network cable and connected to a service network port.

- Aggregation management cabling

For aggregation management, routing the cables from the aggregation network port on the mounting ear.

A server node is accessed through the aggregation network port over the out-of-band management network. The network cable is connected to the aggregation network port, as shown in **Figure 5-2**.

**Figure 5-2** Aggregation management cabling

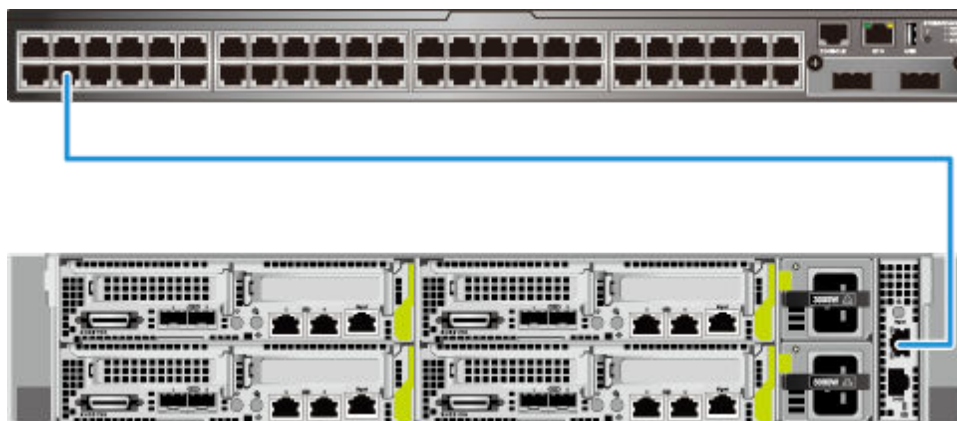

# 6 Technical Specifications

[6.1 Chassis Specifications](#)

[6.2 Node Specifications](#)

[6.3 Power Specifications](#)

[6.4 Environmental Specifications](#)

## 6.1 Chassis Specifications

### Chassis Specifications

**Table 6-1** lists the X6000 technical specifications.

**Table 6-1** X6000 technical specifications

Item	Description
Form factor	2U multi-node server
Server nodes	2U high with 4 nodes
Management ports	<ul style="list-style-type: none"><li>● One aggregation network port to allow unified chassis management.</li><li>● One management network port on each node.</li></ul>
PSUs	Supported 2 x 3000 W AC PSUs (compatible with 240 HVDC) <b>NOTE</b> <ul style="list-style-type: none"><li>● The X6000 PSUs support 1+1 redundancy mode only when the server power consumption is lower than that of a single server.</li><li>● If the input power is between 100 V and 130 V AC, the working power of each PSU will decrease to 1200 W.</li><li>● If the input power is between 200 V and 220 V AC, or 240 V HVDC, the working power of each PSU will decrease to 2500 W.</li><li>● If the input power is between 220 V and 240 V AC, the working power of each PSU is 3000 W.</li></ul>

Item	Description
Fan modules	Four fan modules in N+1 redundancy mode
Dimensions (H x W x D)	<ul style="list-style-type: none"> <li>● Server with 2.5-inch hard disks: 86.1 mm (3.39 in.) × 436 mm (17.17 in.) × 818.9 mm (32.24 in.)</li> <li>● Server with 3.5-inch hard disks: 86.1 mm (3.39 in.) × 436 mm (17.17 in.) × 866.9 mm (34.13 in.)</li> </ul> <p><b>NOTE</b></p> <ul style="list-style-type: none"> <li>● The depth includes the mounting ear size.</li> <li>● The minimum cabinet depth is 1 m (3.28 ft.).</li> </ul>
Weight	<ul style="list-style-type: none"> <li>● Server with 2.5-inch hard disks: 40 kg (88.20 lb)</li> <li>● Server with 3.5-inch hard disks: 45 kg (99.23 lb)</li> <li>● Packing weight: 4.75 kg (10.47 lb)</li> </ul>

## 6.2 Node Specifications

The X6000 holds XH321 V5 server nodes. [Table 6-2](#) describes server node specifications.

**Table 6-2** Server node specifications

Type	Model	Specifications
Chassis	X6000	2U chassis with node slots
Server node	XH321 V5	Optional configuration: <ul style="list-style-type: none"> <li>● One or two Intel® Xeon® Scalable 3100, 4100, 5100, 6100, or 8100 series processors</li> <li>● A maximum of sixteen DDR4 DIMMs</li> <li>● Six 2.5-inch SAS/SATA hard disks or NVMe SSDs, or three 3.5-inch SAS/SATA hard disks</li> <li>● One TPM</li> <li>● Two M.2 SATA SSD cards</li> <li>● Two half-height half-length standard PCIe cards (standard PCIe card slot 1 available for a RAID controller card)</li> </ul>

 **NOTE**

The maximum I/O bandwidth of XH321 V5 hard disks managed through the southbridge is 1.9 GB/s due to the bandwidth limit of the SATA controller integrated in the southbridge.

## 6.3 Power Specifications

The X6000 provides two slots for installing PSUs. [Table 6-3](#) lists power specifications. For details about PSU models, see the [Huawei Server Compatibility Checker](#).

**Table 6-3** Power specifications

PSU Type	Power Rating	Input Voltage	Maximum Input Current per PSU	Output Voltage
AC PSU	3000 W	100 V AC to 130 V AC at 50 Hz or 60 Hz	16 A	12 V
		200 V AC to 220 V AC at 50 Hz or 60 Hz	16 A	
		220 V AC to 240 V AC at 50 Hz or 60 Hz	16 A	
		240 V DC	13 A	

## 6.4 Environmental Specifications

**Table 6-4** describes the X6000 environmental specifications.

**Table 6-4** X6000 chassis environmental specifications

Item	Description
Temperature	Operating temperature: 5°C to 35 (41°F to 95°F) Non-operating temperature: - 40°C to +65°C (-40°F to +149°F) <b>NOTE</b> <ul style="list-style-type: none"> <li>● If a single fan fails, the server node supports the operating temperature ranging from 5°C to 30°C (41°F to 86°F).</li> <li>● If the server node is configured with processors of 125 W or above, the failure of a single fan may affect the server node performance or cause overheating alarms. Replacing the faulty fan can resolve the issues caused by the fan failure.</li> <li>● For the temperature specifications of the server node configured with a RAID controller card supercapacitor and optical modules, see <a href="#">Table 6-5</a> and <a href="#">Table 6-6</a>.</li> </ul>
Relative humidity (non-condensing)	Operating humidity: 8% to 90% RH Storage humidity: 5% to 95% RH
Maximum temperature fluctuation rate	< 20°C/h (68°F/h)

Item	Description
Altitude	<ul style="list-style-type: none"> <li>● Operating altitude <math>\leq 3050</math> m (10006.44 ft)</li> </ul> <p><b>NOTE</b>                      When the server is used at an altitude from 900 m (2952.76 ft) to 3050 m (10006.44 ft), the highest operating temperature decreases by 1°C (1.8°F) for every increase of 300 m (984.25 ft).</p> <ul style="list-style-type: none"> <li>● At an altitude of over 3050 m (10006.44 ft), only Titanium PSUs can be used.</li> <li>● HDDs are not supported at an altitude of over 3050 m (10006.44 ft).</li> </ul>
Vibration	One cyclical sweep in each axial direction at the rate of 0.1 oct/min, with a total of three axial directions 5 Hz to 10 Hz: 5 mm (0.20 in., peak-to-peak value) 10 Hz to 100 Hz: 1 m/s <sup>2</sup>
Shock	Half sine wave, peak acceleration of 2 G, 11 ms, 100 times for each surface, and a total of three axial directions
Acoustic noise	The data listed in the following is the declared A-weighted sound power levels (LWAd) and declared average bystander position A-weighted sound pressure levels (LpAm) when the server is operating at 23°C (73.4°F). Noise emissions are measured in accordance with ISO 7999 (ECMA 74) and declared in accordance with ISO 9296 (ECMA 109). Idle: <ul style="list-style-type: none"> <li>● LWAd: 7.4 Bels</li> <li>● LpAm: 57 dBA</li> </ul> Operating: <ul style="list-style-type: none"> <li>● LWAd: 7.7 Bels</li> <li>● LpAm: 60 dBA</li> </ul> <p><b>NOTE</b>                      The actual sound levels generated when the server is operating vary depending on the server configuration, workload, and ambient temperature.</p>
Input voltage	3000 W: 220 V to 240 V AC at 50 Hz or 60 Hz 2500 W: 200 V to 220 V AC at 50 Hz or 60 Hz; or 240 V DC 1200 W: 100 V to 130 V AC at 50 Hz or 60 Hz
Rated power	The rated power for compatible PSUs: 220 V to 240 V AC : 3000 W 200 V to 220 V AC or 240 V DC: 2500 W 100 V to 130 V AC: 1200 W
Corrosive air pollutant	<ul style="list-style-type: none"> <li>● Corrosion rate of the copper test piece: <math>&lt; 300 \text{ \AA}/\text{month}</math> (in compliance with the ANSI/ISA-71.04-2013 gaseous corrosion level G1).</li> <li>● Corrosion rate of the silver test piece: <math>&lt; 200 \text{ \AA}/\text{month}</math>.</li> </ul>



Item	Description
Particulate pollutant	<ul style="list-style-type: none"> <li>The ISO14664-1 Class 8 requirements are met. You are advised to ask a professional organization to monitor particulate pollutants in the equipment room.</li> <li>There is no explosive, conductive, magnetic, or corrosive dust in the equipment room.</li> </ul>
Power consumption	The power consumption changes depending on the server configuration. For details, see <a href="#">Huawei Server Power Calculator</a> .

**Table 6-5** Maximum temperatures supported by the server configured with a RAID controller card supercapacitor

Hard Disk Backplane	Disk Quantity (Q)	CPU Power	Maximum Temperature
X6000 V5 C00 24*2.5-inch NVMe backplane	16 < Q ≤ 24	P ≤ 165 W	30°C (86°F)
	8 < Q ≤ 16	125 W ≤ P ≤ 165 W	30°C (86°F)
		P < 125 W	35°C (95°F)
X6000 V5 C00 24*2.5-inch SAS backplane	16 < Q ≤ 24	125 W ≤ P ≤ 165 W	32°C (89.6°F)
		P < 125 W	35°C (95°F)
	8 < Q ≤ 16	140 W ≤ P ≤ 165 W	32°C (89.6°F)
		P < 140 W	35°C (95°F)
	0 < Q ≤ 8	P ≤ 165 W	35°C (95°F)
	X6000 V5 C10 24*2.5-inch NVMe backplane	16 < Q ≤ 24	165 W < P ≤ 205 W
P ≤ 165 W			30°C (86°F)
8 < Q ≤ 16		165 W < P ≤ 205 W	/
		125 W ≤ P ≤ 165 W	30°C (86°F)
0 < Q ≤ 8		P < 125 W	35°C (95°F)
		/	/
X6000 V5 C10 24*2.5-inch SAS backplane	16 < Q ≤ 24	165 W < P ≤ 205 W	/
		125 W ≤ P ≤ 165 W	32°C (89.6°F)
		P < 125 W	35°C (95°F)
	8 < Q ≤ 16	165 W < P ≤ 205 W	30°C (86°F)
		140 W ≤ P ≤ 165 W	32°C (89.6°F)
		P < 140 W	35°C (95°F)

	$0 < Q \leq 8$	$165 \text{ W} < P \leq 205 \text{ W}$	32°C (89.6°F)
		$P \leq 165 \text{ W}$	35°C (95°F)
X6000 V5 C10 12*3.5-inch SAS backplane	$8 < Q \leq 12$	$165 \text{ W} < P \leq 205 \text{ W}$	/
		$125 \text{ W} \leq P \leq 165 \text{ W}$	32°C (89.6°F)
		$P < 125 \text{ W}$	35°C (95°F)
	$4 < Q \leq 8$	$165 \text{ W} < P \leq 205 \text{ W}$	30°C (86°F)
		$140 \text{ W} \leq P \leq 165 \text{ W}$	32°C (89.6°F)
		$P < 140 \text{ W}$	35°C (95°F)
	$0 < Q \leq 4$	$165 \text{ W} < P \leq 205 \text{ W}$	32°C (89.6°F)
		$P \leq 165 \text{ W}$	35°C (95°F)
	<b>NOTE</b> For configurations not listed in the table, the maximum temperature is 30°C (86°F). If you need special configurations and temperature requirements, contact Huawei technical support.		

**Table 6-6** Maximum temperatures supported by the server configured with an onboard or PCIe optical module

Hard Disk Backplane	Disk Quantity (Q)	CPU Power	Maximum Temperature	
			With an Onboard Optical Module	With a PCIe Optical Module
X6000 V5 C00 24*2.5-inch NVMe backplane	$16 < Q \leq 24$	$140 \text{ W} < P \leq 165 \text{ W}$	30°C (86°F)	30°C (86°F)
		$125 \text{ W} < P \leq 140 \text{ W}$	35°C (95°F)	30°C (86°F)
		$P \leq 125 \text{ W}$	35°C (95°F)	35°C (95°F)
	$8 < Q \leq 16$	$140 \text{ W} < P \leq 165 \text{ W}$	30°C (86°F)	30°C (86°F)
		$125 \text{ W} < P \leq 140 \text{ W}$	35°C (95°F)	30°C (86°F)
		$P \leq 125 \text{ W}$	35°C (95°F)	35°C (95°F)

	$0 < Q \leq 8$	$140 \text{ W} < P \leq 165 \text{ W}$	$35^{\circ}\text{C}$ (95°F)	$30^{\circ}\text{C}$ (86°F)	
		$P \leq 140 \text{ W}$	$35^{\circ}\text{C}$ (95°F)	$35^{\circ}\text{C}$ (95°F)	
X6000 V5 C00 24*2.5-inch SAS backplane	$16 < Q \leq 24$	$140 \text{ W} < P \leq 165 \text{ W}$	$35^{\circ}\text{C}$ (95°F)	$30^{\circ}\text{C}$ (86°F)	
		$P \leq 140 \text{ W}$	$35^{\circ}\text{C}$ (95°F)	$30^{\circ}\text{C}$ (86°F) (10GE optical module: $35^{\circ}\text{C}$ (95°F))	
	$8 < Q \leq 16$	$140 \text{ W} < P \leq 165 \text{ W}$	$35^{\circ}\text{C}$ (95°F)	$30^{\circ}\text{C}$ (86°F)	
		$P \leq 140 \text{ W}$	$35^{\circ}\text{C}$ (95°F)	$35^{\circ}\text{C}$ (95°F)	
	$0 < Q \leq 8$	$P \leq 165 \text{ W}$	$35^{\circ}\text{C}$ (95°F)	$35^{\circ}\text{C}$ (95°F)	
X6000 V5 C10 24*2.5-inch NVMe backplane	$16 < Q \leq 24$	$165 \text{ W} < P \leq 205 \text{ W}$	/	/	
		$140 \text{ W} < P \leq 165 \text{ W}$	$30^{\circ}\text{C}$ (86°F)	$30^{\circ}\text{C}$ (86°F)	
		$125 \text{ W} < P \leq 140 \text{ W}$	$35^{\circ}\text{C}$ (95°F)	$30^{\circ}\text{C}$ (86°F)	
		$P \leq 125 \text{ W}$	$35^{\circ}\text{C}$ (95°F)	$35^{\circ}\text{C}$ (95°F)	
	$8 < Q \leq 16$	$165 \text{ W} < P \leq 205 \text{ W}$	/	/	
		$140 \text{ W} < P \leq 165 \text{ W}$	$30^{\circ}\text{C}$ (86°F)	$30^{\circ}\text{C}$ (86°F)	
		$125 \text{ W} < P \leq 140 \text{ W}$	$35^{\circ}\text{C}$ (95°F)	$30^{\circ}\text{C}$ (86°F)	
		$P \leq 125 \text{ W}$	$35^{\circ}\text{C}$ (95°F)	$35^{\circ}\text{C}$ (95°F)	

	$0 < Q \leq 8$	$165\text{ W} < P \leq 205\text{ W}$	$30^{\circ}\text{C}$ (86°F)	$30^{\circ}\text{C}$ (86°F)
		$140\text{ W} < P \leq 165\text{ W}$	$35^{\circ}\text{C}$ (95°F)	$30^{\circ}\text{C}$ (86°F)
		$P \leq 140\text{ W}$	$35^{\circ}\text{C}$ (95°F)	$35^{\circ}\text{C}$ (95°F)
X6000 V5 C10 24*2.5-inch SAS backplane	$16 < Q \leq 24$	$165\text{ W} < P \leq 205\text{ W}$	/	/
		$140\text{ W} < P \leq 165\text{ W}$	$35^{\circ}\text{C}$ (95°F)	$30^{\circ}\text{C}$ (86°F)
		$P \leq 140\text{ W}$	$35^{\circ}\text{C}$ (95°F)	$30^{\circ}\text{C}$ (86°F) (10GE optical module: $35^{\circ}\text{C}$ (95°F))
	$8 < Q \leq 16$	$165\text{ W} < P \leq 205\text{ W}$	$30^{\circ}\text{C}$ (86°F)	$30^{\circ}\text{C}$ (86°F)
		$140\text{ W} < P \leq 165\text{ W}$	$35^{\circ}\text{C}$ (95°F)	$30^{\circ}\text{C}$ (86°F)
		$P \leq 140\text{ W}$	$35^{\circ}\text{C}$ (95°F)	$35^{\circ}\text{C}$ (95°F)
	$0 < Q \leq 8$	$165\text{ W} < P \leq 205\text{ W}$	$35^{\circ}\text{C}$ (95°F)	$30^{\circ}\text{C}$ (86°F)
		$P \leq 165\text{ W}$	$35^{\circ}\text{C}$ (95°F)	$35^{\circ}\text{C}$ (95°F)
	X6000 V5 C10 12*3.5-inch SAS backplane	$8 < Q \leq 12$	$165\text{ W} < P \leq 205\text{ W}$	/
$140\text{ W} < P \leq 165\text{ W}$			$35^{\circ}\text{C}$ (95°F)	$30^{\circ}\text{C}$ (86°F)
$P \leq 140\text{ W}$			$35^{\circ}\text{C}$ (95°F)	$30^{\circ}\text{C}$ (86°F) (10GE optical module: $35^{\circ}\text{C}$ (95°F))
$4 < Q \leq 8$		$165\text{ W} < P \leq 205\text{ W}$	$30^{\circ}\text{C}$ (86°F)	$30^{\circ}\text{C}$ (86°F)

		140 W < P ≤ 165 W	35°C (95°F)	30°C (86°F)
		P ≤ 140 W	35°C (95°F)	35°C (95°F)
	0 < Q ≤ 4	165 W < P ≤ 205 W	35°C (95°F)	30°C (86°F)
		P ≤ 165 W	35°C (95°F)	35°C (95°F)
<b>NOTE</b> For configurations not listed in the table, the maximum temperature is 30°C (86°F). If you need special configurations and temperature requirements, contact Huawei technical support.				

**Table 6-7** describe the heat dissipation requirements of X6000 CPUs of different models.

**Table 6-7** Heat dissipation requirements of the server configured with CPUs of different models

Hard Disk Backplane	CPU Model	Heatsink	Disks and DIMMs	Maximum Inlet Temperature
X6000 V5 C00 24*2.5-inch SAS backplane	Intel® Xeon® 3100, 4100, 5100, 6100, and 8100 processors (165 W and lower)	Narrow heat sink	<ul style="list-style-type: none"> <li>● Disks ≤ 24</li> <li>● DIMMs ≤ 16</li> </ul>	35°C (95°F)
X6000 V5 C00 24*2.5-inch NVMe backplane	Intel® Xeon® 3100, 4100, 5100, 6100, and 8100 processors (165 W and lower)	Narrow heat sink	<ul style="list-style-type: none"> <li>● Disks ≤ 24</li> <li>● DIMMs ≤ 16</li> </ul>	35°C (95°F)
X6000 V5 C10 24*2.5-inch NVMe backplane	Intel® Xeon® 3100, 4100, 5100, 6100, and 8100 processors (205 W and lower)	Wide heat sink	<ul style="list-style-type: none"> <li>● 0 &lt; Disks ≤ 8</li> <li>● DIMMs ≤ 12</li> </ul>	30°C (86°F)
	Intel® Xeon® 3100, 4100, 5100, 6100, and 8100 processors (165 W and lower)	Narrow heat sink	<ul style="list-style-type: none"> <li>● Disks ≤ 24</li> <li>● DIMMs ≤ 16</li> </ul>	35°C (95°F)

Hard Disk Backplane	CPU Model	Heatsink	Disks and DIMMs	Maximum Inlet Temperature
X6000 V5 C10 24*2.5-inch SAS backplane	Intel® Xeon® 3100, 4100, 5100, 6100, and 8100 processors (205 W and lower)	Wide heat sink	● 8 < Disks ≤ 16 ● DIMMs ≤ 12	30°C (86°F)
			● 0 < Disks ≤ 8 ● DIMMs ≤ 12	35°C (95°F)
	Intel® Xeon® 3100, 4100, 5100, 6100, and 8100 processors (165 W and lower)	Narrow heat sink	● Disks ≤ 24 ● DIMMs ≤ 16	35°C (95°F)
X6000 V5 C10 12*3.5-inch SAS backplane	Intel® Xeon® 3100, 4100, 5100, 6100, and 8100 processors (205 W and lower)	Wide heat sink	● 4 < Disks ≤ 8 ● DIMMs ≤ 12	30°C (86°F)
			● 0 < Disks ≤ 4 ● DIMMs ≤ 12	35°C (95°F)
	Intel® Xeon® 3100, 4100, 5100, 6100, and 8100 processors (165 W and lower)	Narrow heat sink	● Disks ≤ 12 ● DIMMs ≤ 16	35°C (95°F)
<b>NOTE</b>				
● For details about CPU models, see the <a href="#">Server Compatibility Checker</a> .				

**Table 6-8** describes the environment and air intake requirements of the X6000.

**Table 6-8** X6000 environment and air intake requirements

Server Power	Environment and Air Intake Requirements
2000 W to 3000 W	<ul style="list-style-type: none"> <li>● Intel temperature: 35°C (95°F)</li> <li>● Wind speed for a server: ≥ 300 CFM</li> <li>● Cooling capacity for a server: ≥ 3000 W</li> </ul>
< 2000 W	<ul style="list-style-type: none"> <li>● Intel temperature: 35°C (95°F)</li> <li>● Wind speed for a server: ≥ 200 CFM</li> <li>● Cooling capacity for a server: ≥ 2000 W</li> </ul>

# 7 Maintenance

According to the Huawei Warranty Policy for Servers & Storage Products (Warranty Policy for short), the X6000 has a three-year warranty, the DVD-ROM drive and iBBU have a one-year warranty, and the software media have a three-month warranty. The Warranty Policy stipulates warranty terms and conditions, including the available services, response time, terms of service, and disclaimer.

The warranty terms and conditions may vary by country, and some services and/or parts may not be available in all countries. For more information about warranty services in your country, contact Huawei technical support or the local Huawei office.

**Table 7-1** describes the warranty service response time.

**Table 7-1** Response time

Service	Response Time	Description	Remarks
Help Desk	24/7	Available 24 hours a day, 7 days a week (00:00 to 24:00, Monday to Sunday)	None
Remote troubleshooting	24/7	Available 24 hours a day, 7 days a week (00:00 to 24:00, Monday to Sunday)	The response time starts from the time when Huawei technical support accepts a customer's service request to the time when the technical support contacts the customer the first time to provide remote troubleshooting services.

Service	Response Time		Description	Remarks
Online technical support	24/7		You can obtain online support at Huawei's website. This service is available 24 hours a day (00:00 to 24:00), 7 days a week (Monday to Sunday).	None
Software update authorization	24/7		You can obtain online support at Huawei's website. This service is available 24 hours a day (00:00 to 24:00), 7 days a week (Monday to Sunday).	None
Return for repair	Out side Chi na	Outside China 9/5 hours, 45 calendar days shipment	Available 9 hours a day (09:00 to 18:00), 5 days a week (Monday to Friday), excluding official holidays.	The repaired or replacement parts will be shipped within 45 calendar days after Huawei receives the defective parts.
	Chi na	NBD, 9 hours a day, 5 days a week	Available 9 hours a day (09:00 to 18:00), 5 days a week (Monday to Friday), excluding official holidays.	Service requests submitted after 15:30 will be handled the next business day.

**Table 7-2** describes the warranty services provided by Huawei.

**Table 7-2** Warranty services

Service	Description
Help Desk	Huawei provides 24-hour after-sales technical support (such as handling requests for troubleshooting and hardware repair), receives and handles customer inquiries, complaints, and suggestions through a dedicated hotline.
Remote troubleshooting	After receiving a service request for rectifying a network or system fault, Huawei engineers will first analyze and handle the fault remotely and rectify it in the shortest possible time. There are two methods for remote troubleshooting: telephone support and remote access.



Service	Description
Online technical support	Huawei enterprise support website ( <a href="http://e.huawei.com">http://e.huawei.com</a> ) provides product and technical materials, such as product manuals, configuration guides, networking case study, and maintenance experience collections. Registered users can access the website and download required documents.
Software update authorization	To ensure that the devices operate stably, Huawei provides software patches whenever necessary.
Return for repair	<p>Huawei provides repair or replacement services for customers within the promised time to meet customer needs for spare parts. You can return defective parts to the designated Huawei site after submitting a service request.</p> <p>Huawei provides a three-year warranty for parts replacement and onsite repair for the RH1288 V2 used in China. Huawei provides a 9-hour-a-day, 5-day-a-week support program. Service requests will be handled the next business day.</p> <p>Huawei provides a three-year warranty for parts replacement and repair for the X6000 used outside China. Huawei provides a 9-hour-a-day, 5-day-a-week support program. Service requests will be handled the next business day. Huawei delivers the repaired or new parts within 45 calendar days after receiving the defective parts.</p>

# 8 Certifications





8.1 Certifications







8.2 Standards and Protocols

## 8.1 Certifications

**Table 8-1** lists the certifications that the X6000 has passed.

**Table 8-1** X6000 certifications

Region	Country	Certification Name	Certification Label	Compulsory or Voluntary	X6000
China	China	CCC		Compulsory	
		RoHS&REACH&WEEE		Compulsory	
		CQC	N/A	Voluntary	
Europe	EU	CE-SDOC		Compulsory	
		EPR	N/A	Compulsory	
	Customs Union (CU) member countries (Russia, White Russia, and Kazakhstan)	CU		Compulsory	
	Czech	CE-SDOC		Compulsory	

Region	Country	Certification Name	Certification Label	Compulsory or Voluntary	X6000
		RoHS&REACH H&WEEE		Compulsory	
North American	US	FCC-SDOC	Warning	Compulsory	
		NRTL-UL		Compulsory	
		Energy Star	Warning	Voluntary	
	Canada	IC-SDOC	Warning	Compulsory	
		NRTL-U		Compulsory	
Asia Pacific	Australia	RCM		Compulsory	
	Japan	VCCI	VCCI-A	Voluntary	
Latin America	Mexico	NRTL-UL		Compulsory	
Middle East West Africa North Africa	Turkey	CE-SDOC	CE	Compulsory	
	Nine-country certification (Multi-Country Certification: Saudi, Nigeria, Tanzania, Uganda, Kuwait, Algeria, Botswana, Qatar, Egypt)	Nine-Country Certification	N/A	Compulsory	
Global	IECEE members	CB		Voluntary	
Note: For details about the certifications, see the <i>Tecal Server Certificate Map</i> . The certification information is for reference only.					

## 8.2 Standards and Protocols

**Table 8-2** lists the standards and protocols to which the X6000 conforms.

**Table 8-2** Standards and protocols to which the X6000 conforms

Category	Standard/Protocol	Description
Standard	IEEE 802.1P	QoS
	IEEE 802.1Q	VLAN
	IEEE 802.1D	Bridge/Spanning Tree
	IEEE 802.3	Ethernet
	IEEE 802.3u	Fast Ethernet (FE)
	IEEE 802.3x	Flow control
	IEEE 802.3z	Gigabit Ethernet
	IEEE 1149.1-2001	IEEE standard test access port and boundary-scan architecture
	IEC 812	Procedure for Failure Mode and Effects Analysis (FMEA)
	IEC 863	Presentation of reliability, maintainability and availability predictions
	IEC60297	Chassis compliance
	IEC60950	Safety
	IEC60825-1/2/6	Safety
	IEC60215	Safety
	IEC61000	EMC
	UL60950	Safety (North America)
	EN60950	Safety (Europe)
	ECMA TR/70	Environmental protection
	GR-929	Reliability
	Telcordia SR-332	Reliability
ETS	European Telecommunications Standards	
Protocol	IP	Internet Protocol
	ARP	Address Resolution Protocol
	ICMP	Internet Control Message Protocol
	IGMP	Internet Group Management Protocol
	SNMP	Simple Network Management Protocol
	TELNET	Remote Terminal Protocol

Category	Standard/Protocol	Description
	HTTP	Hypertext Transfer Protocol
	TFTP	Trivial File Transfer Protocol
	FTP	File Transfer Protocol
	IPMI	Intelligent Platform Management Interface

---

# A Acronyms and Abbreviations

---

## A

<b>AC</b>	Alternating Current
<b>AES NI</b>	Advanced Encryption Standard New Instruction Set
<b>ARP</b>	Address Resolution Protocol
<b>AVX</b>	Advanced Vector Extensions

## B

<b>BBU</b>	Backup Battery Unit
<b>BMC</b>	Baseboard Management Controller

## C

<b>CD</b>	Calendar Day
<b>CIM</b>	Common Information Model
<b>CLI</b>	Command-line Interface

## D

<b>DC</b>	Direct Current
<b>DDR3</b>	Double Data Rate 3
<b>DDR4</b>	Double Data Rate 4
<b>DEMT</b>	Dynamic Energy Management Technology
<b>DIMM</b>	Dual In-line Memory Module
<b>DVD</b>	Digital Video Disc

## E

<b>ECC</b>	Error Checking and Correcting
------------	-------------------------------

<b>ECMA</b>	European Computer Manufacturers Association
<b>EDB</b>	Execute Disable Bit
<b>EN</b>	European Efficiency
<b>ETS</b>	European Telecommunications Standards
<b>F</b>	
<b>FC</b>	Fiber Channel
<b>FTP</b>	File Transfer Protocol
<b>G</b>	
<b>GE</b>	Gigabit Ethernet
<b>GPIO</b>	General Purpose Input/Output
<b>H</b>	
<b>HDD</b>	Hard Disk Drive
<b>HMM</b>	Hyper Management Module
<b>HPC</b>	High-performance Computing
<b>HTTP</b>	Hypertext Transfer Protocol
<b>HTTPS</b>	Hypertext Transfer Protocol Secure
<b>HVDC</b>	High Voltage Direct Current
<b>I</b>	
<b>ICMP</b>	Internet Control Message Protocol
<b>IDC</b>	Internet Data Center
<b>IEC</b>	<a href="#"><b>International Electrotechnical Commission</b></a>
<b>IEEE</b>	Institute of Electrical and Electronics Engineers
<b>IGMP</b>	Internet Group Message Protocol
<b>iBMC</b>	Integrated Baseboard Management Controller
<b>IOPS</b>	Input/Output Operations per Second
<b>IP</b>	Internet Protocol
<b>IPC</b>	Intelligent Power Capability
<b>IPMB</b>	Intelligent Platform Management Bus
<b>IPMI</b>	Intelligent Platform Management Interface
<b>K</b>	

---

<b>KVM</b>	Keyboard Video and Mouse
<b>L</b>	
<b>LC</b>	Lucent Connector
<b>LDIMM</b>	Local Dual In-line Memory Module
<b>LED</b>	Light Emitting Diode
<b>M</b>	
<b>MAC</b>	Media Access Control
<b>N</b>	
<b>NBD</b>	Next Business Day
<b>NC-SI</b>	Network Controller Sideband Interface
<b>P</b>	
<b>PCIe</b>	Peripheral Component Interconnect Express
<b>PHY</b>	Physical Layer
<b>PMBUS</b>	Power Management Bus
<b>POK</b>	Power OK
<b>PWM</b>	Pulse-width Modulation
<b>Q</b>	
<b>QPI</b>	QuickPath Interconnect
<b>R</b>	
<b>RAID</b>	Redundant Array of Independent Disks
<b>RDIMM</b>	Registered Dual In-line Memory Module
<b>RJ45</b>	Registered Jack 45
<b>S</b>	
<b>SAS</b>	Serial Attached Small Computer System Interface
<b>SATA</b>	Serial Advanced Technology Attachment
<b>SGMII</b>	Serial Gigabit Media Independent Interface
<b>SMTP</b>	Simple Mail Transfer Protocol
<b>SM_CLP</b>	Server Management Command Line Protocol
<b>SNMP</b>	Simple Network Management Protocol



<b>SSD</b>	Solid-state Drive
<b>T</b>	
<b>TACH</b>	Tachometer signal
<b>TBT</b>	Turbo Boost Technology
<b>TCG</b>	Trusted Computing Group
<b>TDP</b>	Thermal Design Power
<b>TELNET</b>	Telecommunication Network Protocol
<b>TET</b>	Trusted Execution Technology
<b>TFTP</b>	Trivial File Transfer Protocol
<b>TPM</b>	Trusted Platform Module
<b>U</b>	
<b>UDIMM</b>	Unbuffered Dual In-line Memory Module
<b>UEFI</b>	Unified Extensible Firmware Interface
<b>UID</b>	Unit Identification Light
<b>UL</b>	Underwriter Laboratories Inc.
<b>USB</b>	Universal Serial Bus
<b>V</b>	
<b>VGA</b>	Video Graphics Array
<b>VRD</b>	Voltage Regulator-Down
<b>W</b>	
<b>WSMAN</b>	Web Service Management